



HM50B

Owner's Manual

⚠ PLEASE PRACTICE SAFE FIREARMS HANDLING!

WARNING: BEFORE USING THIS FIREARM, READ AND FOLLOW ALL INSTRUCTIONS.

Visit www.hmdefense.com for instructional videos.

THE OWNER'S MANUAL SHOULD ALWAYS ACCOMPANY YOUR HM50B RIFLE AND BE TRANSFERRED WITH IT UPON CHANGE OF OWNERSHIP.

This manual contains operating, care and maintenance instructions. To ensure safe operation, any user of this firearm must read and understand this manual before using the firearm. Failure to follow the instructions and heed the warnings in this manual may result in property damage, serious personal injury, and death.

WARNING: Keep this firearm out of the reach of children, unauthorized individuals, and others unfamiliar with safe handling of firearms.

	ALERT SYMBOLS AND DEFINITIONS
WARNING!	Indicates a hazardous situation which, if not avoided, could result in property damage, personal injury, or death.
CAUTION!	Indicates a hazardous situation which, if not avoided, could result in minor to moderate personal injury.
NOTE:	Addresses practices not related to personal injury.



HM50B SPECIFICATIONS AT A GLANCE

- Chambered in .50 BMG, the HM50B has a 29.25", 8 groove barrel with 1:15 twist ratio.
- Bolt 9310 steel, Bolt Carrier 4140 steel.
- Muzzle tread 1"-14 TPI. Match grade: button rifled for superior accuracy.
- 14" 1913 Picatinny free floated, billet rail CNC machined from aircraft grade aluminum.
- 7075-T6 billet upper receiver with 1913 Picatinny flat top rail. Left bolt/right port.
- HM50B billet lower receiver CNC machined from aircraft grade aluminum.
- HM Defense target trigger.
- Accu-Tac HD-50 Bipod with sled feet.
- Ergo Tactical Deluxe Grip – Suregrip (Ambi)
- Magpul PRS Gen3 Precision- Adjustable Stock.
- Case with custom fitted foam.
- 10 Round Magazine
- Weight: 29 lb. Cerakote Colors: Black, Tungsten, & FDE

THANK YOU FOR PURCHASING AN HM DEFENSE FIREARM!

TABLE OF CONTENTS

10 RULES OF FIREARMS SAFETY	1 - 9
SERIAL NUMBER & CALIBER AMMUNITION	10 - 11
IMPORTANT PARTS OF THE HM50B	12 - 13
THE SAFETY MECHANISM	14 - 15
ASSEMBLING THE HM50B	16 - 17
LOADING THE HM50B	18 - 22
UNLOADING THE HM50B	22 - 23
THE BARREL	23
CHECKING FOR OBSTRUCTIONS	23
REMOVING OBSTRUCTIONS	24
FIRING THE HM50B	25 - 26
CLEANING, LUBRICATION, AND MAINTENANCE	27
DISASSEMBLING FOR CLEANING	28 - 32
CLEANING AND LUBRICATION	33 - 34
REASSEMBLING THE HM50B	34 - 37
FUNCTION TESTING THE HM50B	38 - 40
REPAIR INSTRUCTIONS	41 - 42
WARRANTY – SUPPRESSOR INSTALLATION	43 - 44

Congratulations on your purchase of an HM Defense HM50B. With the proper care, your HM50B will give you many years of accurate, dependable, and enjoyable use.

The HM50B was designed to withstand extreme use in harsh environments. Manufactured in Ohio from only the highest quality materials, the HM50B is engineered for durability and accuracy. HM Defense is always innovating to give our customers the most accurate, dependable, and rugged firearms available.

Thank you for choosing HM Defense.

HM50B

PATENT PENDING



10 RULES OF FIREARMS SAFETY

The 10 Rules of Firearms Safety should be always adhered to and committed to memory. These rules should govern your actions whenever and wherever you are involved with firearms in the field, on the range, or in your home. Please take the time to review and understand these rules.



RULE #1 – ALWAYS KEEP THE MUZZLE POINTED IN A SAFE DIRECTION

This is the most important firearm safety rule. A safe direction is one in which an accidental discharge will not cause injury to yourself or others, taking into account possible ricochets and the fact that bullets can penetrate walls and ceilings. The safe direction may be “up” on some occasions or “down” on others, but never at anyone or anything not intended as a target. Always be aware of your target and what is beyond. Never allow your firearm to point at anything you do not intend to shoot. Be especially careful when you are loading and unloading. Treat every firearm as if it were loaded. Make it a habit to know where the muzzle is pointed at all times, even when your firearm is unloaded. No one will be injured by an accidental discharge if you keep your firearm pointed in a safe direction. **It is that simple and it is your responsibility.**



RULE #2 – FIREARMS SHOULD BE UNLOADED WHEN NOT IN USE

Load your firearm only when you are in the field or on the target range and ready to fire. Never let a loaded firearm out of your sight or out of your hands. Unload it as soon as you are finished shooting and before you bring it into your vehicle, camp, or home. Remember, unloading your

firearm means unloading it completely, so there is no ammunition in the chamber or in the magazine. Before handling a firearm or passing it to someone else, visually check the chamber, receiver, and magazine to be certain they do not contain ammunition. Always keep the firearm's action open when not in use. Never assume a firearm is unloaded even if you were the last person to use it. Always check it yourself.

Let common sense rule when you carry a loaded firearm. If you are in a situation that could risk accidental discharge such as crossing a fence, wading through a stream, or climbing a tree, always unload your firearm. Never pull or push a loaded firearm toward yourself or another person. Never carry a loaded firearm in a scabbard, detached holster, or gun case.

Certain firearms are equipped with internal security devices to prevent unauthorized use. In addition, some firearms owners use external devices, such as cable locks and trigger blocks for the same purpose. Even if you use such a device, you should always keep your firearm unloaded when stored or not in use. Using internal or external devices cannot substitute for securing your firearms and ammunition in a separate, locked location.

Safe storage of firearms is just as critical as safe handling. Never store firearms loaded. Be sure to keep your firearms in a secure place where unauthorized persons cannot get their hands on them without your knowledge.

Take special care if there are children around. Children are fascinated by firearms. It is natural curiosity that can have tragic consequences when not properly supervised. **Store your firearms in a locked gun safe or some other location that physically bars a child from gaining access.**

Ammunition should be stored and locked in a location separate from your firearm. Never leave an unsecured firearm or ammunition in a closet dresser drawer or under the bed. Remember, it is your responsibility to make sure that children, unauthorized individuals, and others unfamiliar with firearms cannot get access to your firearm and ammunition.



RULE #3 – DO NOT RELY ON YOUR FIREARM’S SAFETY

Treat every firearm as if it can fire at any time, whether or not there is pressure on the trigger. Your firearm has been carefully designed to maximize performance and safety. However, because a firearm’s safety is a mechanical device, it could fail. Human error is a more likely reason for a firearm safety to fail. By mistake, you may think the safety is on when it really is not. The safety may have been disengaged without your knowledge. You may think your firearm is unloaded when there is a cartridge or shell in it. A mechanical safety is not a substitute for common sense and responsibility. It is merely a supplement to your proper handling of a firearm.

Never touch the trigger on a firearm until you are ready to shoot! KEEP YOUR FINGERS OFF AND AWAY FROM THE TRIGGER when you are loading and unloading. Do not pull the trigger when the safety is engaged or positioned between safe and fire.

Before using your firearm, read this instruction manual to understand the exact location and operation of your firearm’s safety. Even when the safety is on, maintain control of your loaded firearm and control the direction of the muzzle. Do not rely on your safety to justify careless handling. If your firearm’s internal mechanisms are broken or have been altered, your firearm may fire even when the safety is on. Remember, you and your safe firearm handling practices are your firearm’s best safety.



RULE #4 – BE SURE OF YOUR TARGET AND WHAT IS BEYOND IT

You cannot stop a bullet once it has been fired. NEVER FIRE UNLESS YOU KNOW EXACTLY WHERE YOUR SHOT IS GOING AND WHAT IT WILL STRIKE. Never fire at a sound, a movement, or a patch of color. A hunter in camouflage can easily be mistaken for a target by an impulsive shooter. Before you pull the trigger be sure of your target and what is behind it. Make sure the shot has a backstop such as a hillside or dense material like sand. Bullets can travel great distances with tremendous velocity. Know how far your shot will go if you miss your target or if the bullet ricochets.



RULE #5 – USE PROPER AMMUNITION

Every firearm is designed to use a certain caliber or gauge of ammunition. Using the wrong ammunition, mixing ammunition, or using improperly reloaded ammunition can cause serious personal injury or death. It only takes one cartridge of the incorrect caliber, or one which has been improperly reloaded to destroy your firearm. Always read and heed the instructions on ammunition boxes. Refer to your HM50B Informational Reference for ammunition requirements and recommendations.

Confusing cartridges can cause serious personal injury or death and destroy your firearm. Examine your cartridges closely and use the precise caliber for your specific firearm.

Check all ammunition before you load it to make sure it matches your firearm's requirements. Every cartridge should be head-stamped with its caliber for easy identification. Likewise, you will find the caliber of your new HM Defense firearm imprinted on the barrel.

RELOADING REQUIRES EXTRA DILIGENCE

If you reload ammunition, then you are responsible for ensuring that the components you use, and the performance of your loads meets SAAMI guidelines for safety and performance – the same guidelines your firearm was tested to at the factory. Never use ammunition which has been reloaded by someone else. Reloading requires a thorough knowledge of reloading procedures and a deep respect for the explosive potential of gunpowder. Reloading incorrectly, whether by deviating from load specifications established by powder or component manufacturer’s recommendations or exceeding “maximum loads” could result in severe injury to yourself, bystanders, or severe damage to your firearm. Dangerously high pressure can result from an overcharge of powder or other deviations from established reloading guidelines creating the potential for severe damage to your firearm and possible personal injury and/or death to you and/or bystanders. If you chose to reload, be extremely careful.

WARNING! Discharging firearms in poorly ventilated areas, cleaning firearms, or handling ammunition may result in exposure to lead, a substance known to cause birth defects, reproductive harm, and other serious physical injury. Always have adequate ventilation. Wash hands thoroughly after exposure.



**RULE #6 – IF YOUR FIREARM FAILS TO FIRE WHEN THE TRIGGER IS PULLED,
HANDLE WITH CARE**

If for some reason the ammunition does not fire when the trigger is pulled, STOP and keep the muzzle pointed in a safe direction. Keep your face away from the firearm and place the safety

on. Carefully open the action, unload the firearm, and dispose of the cartridge safely. Remember that anytime there is a cartridge in the chamber, your firearm is loaded and ready to use. Even if you tried to shoot and your firearm did not fire, treat your firearm as if it could still discharge.



RULE #7 – ALWAYS WEAR EYE & HEARING PROTECTION WHEN SHOOTING

Your sight and hearing risk injury from shooting and should be protected at all times. Wear protective shooting glasses to guard against falling shot, clay target chips, powder residue, ruptured cartridge cases and even twigs and branches in the field. Be sure to wear eye protection when you are disassembling or cleaning a firearm so that tensioned parts, like springs, and cleaning solvents do not come in contact with your eyes. Continued exposure to shooting noise can permanently damage your hearing. On the range, where shooting volume is the loudest, be sure to use the maximum protection of a headset. Learn to use hearing protection at all times.



RULE #8 – BE SURE THE BARREL IS CLEAR OF OBSTRUCTIONS BEFORE SHOOTING

Before loading your firearm, open the action and make sure there is no ammunition in the chamber or magazine. Check the barrel for any obstructions or debris. Even a small amount of snow, mud, excess lubricant, or grease in the bore can dangerously increase pressure and cause the barrel to bulge or burst when firing. Use a cleaning rod and patch to wipe away anti-rust compounds or any other residues or obstructions in the barrel. Never try to shoot out an obstruction by loading another shell and firing.

When firing, rely on your instincts. If the noise or recoil of your firearm seems weak, stop everything. Unload your firearm and make sure nothing is lodged in the barrel.



**RULE #9 – DO NOT ALTER OR MODIFY YOUR FIREARM.
HAVE YOUR FIREARM SERVICED REGULARLY.**

Your firearm has been designed to operate according to certain factory specifications. You will jeopardize your safety and that of others around you by attempting to alter its trigger, mechanical safety, or other mechanisms. **Never alter or modify your firearm in any way.**

Like any mechanical device, a firearm is subject to wear. It must be maintained and periodically serviced to assure optimum safety and performance. Only HM Defense should service, repair, or modify your HM Defense firearm. Consult page 42 of the owner's manual for instructions on how to send your firearm to the factory.

Proper cleaning and lubrication are also important to firearm maintenance and are necessary to assure accuracy, safety, and reliability. Before cleaning, always make sure that your firearm is completely unloaded. Always clean the barrel from the chamber end to the muzzle.

Make it a practice to clean your bore every time you are going to shoot. Be sure to clean and lubricate your entire firearm before and after long-term storage and no less than once a year. It is also important to clean your firearm whenever it has been exposed to adverse conditions such as rain, dirt, mud, snow, sleet, or saltwater.

For safe and dependable operation of your firearm, all parts of your firearm must be properly cleaned and lubricated. Periodically inspect the internal workings of your firearm to be sure they are clean and free of rust, unwanted dirt, and debris.

Use recommended lubricants on your firearm and do not over-lubricate. Excessive use of a non-recommended lubricant could adversely affect the function and safe operation of your firearm. Remember, you are responsible for the proper care and maintenance of your firearm. Failure to properly maintain your firearm cannot only damage or ruin your firearm, it can expose you and others to unnecessary risks of personal injury or death.



RULE #10 – LEARN THE MECHANICS AND HANDLING CHARACTERISTICS OF YOUR FIREARM

Not all firearms are alike. They have different mechanical characteristics that dictate how you should carry and handle them. Anyone who plans to use a firearm should first become totally familiar with the type of firearm it is and the safe handling procedures for loading, unloading, carrying, shooting and storing that firearm.

Before you even unpack your new HM Defense firearm, read this instruction book from cover to cover and familiarize yourself with the different component parts of the firearm. Read, understand, and follow the 10 RULES OF FIREARM SAFETY.

**ALWAYS SHOOT SOBER! NEVER CONSUME ANYTHING THAT WOULD IMPAIR YOUR
JUDGEMENT OR PHYSICAL COORDINATION WHEN YOU ARE USING A FIREARM.**

WARNING! Failure to follow any of these safety rules may cause personal injury or death to the shooter or bystander and damage to property. Do not use a firearm until you fully understand and practice the 10 RULES OF FIREARMS SAFETY. If you have any questions about the safe use of an HM Defense firearm, please contact HM Defense at info@hmdefense.com or 937-444-6500.

WARNING! If a firearm is carelessly or improperly handled, unintentional discharge can result in property damage, personal injury, and/or death.

WARNING! Never place your finger on the trigger unless you are ready to discharge the firearm even when the safety is engaged. An unintentional or uncontrolled discharge of your firearm may cause property damage, personal injury, and/or death.

WARNING! Use only clean, dry, high quality, commercially manufactured ammunition in good condition which is appropriate to the caliber of your firearm. HM Defense recommends against the use of SLAP, remanufactured ammunition, and urges extreme caution with reloaded or hand-loaded ammunition. The use of improperly loaded, hand-loaded, or reloaded ammunition may cause property damage, personal injury, and/or death.

NOTE: Using surplus ammunition may result in out of tolerance cases with hard bolt closure/opening, stuck cases upon firing, and overpressure loads creating dangerous conditions. See recommended ammunitions on the HM50B Informational Reference.

HM Defense strongly recommends against the use of .50 BMG rounds offered as “military surplus.” Such products often produce higher-than-expected pressures and can damage your rifle.

SERIAL NUMBER AND CALIBER AMMUNITION

The serial number of your firearm is located on the left side of the magazine well. The correct cartridge marking intended for use in your firearm are located on left side of the magazine well and the barrel.

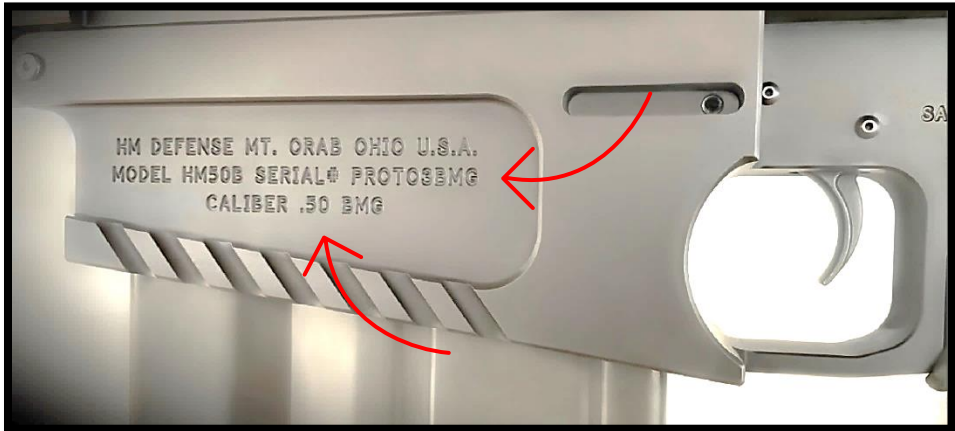

WARNING! Only use ammunition designated by the caliber marking on the barrel and lower receiver. Using ammunition not designated by the barrel (improper caliber) may cause property damage, personal injury and/or death.

Always check the cartridge for the correct caliber marking before loading the firearm. The caliber of a cartridge is located on the cartridge head. **SEE FIGURE 1 BELOW.**



FIGURE 1

WARNING! Do not apply oil, grease, or any lubricants to cartridges. Applying lubricants to cartridges may interfere with proper operation of the cartridge, resulting in property damage, personal injury and/or death.

WARNING! As military ammunition does not have a headstamp indicating the cartridge type, it is the responsibility of the user to determine the cartridge type of the ammunition before use. Using improper ammunition may cause property damage, personal injury, and/or death.

IMPORTANT PARTS OF THE HM50B

This picture shows the main parts of the HM50B, .50 BMG Bolt Action Rifle. This picture will aid in identifying and locating features and parts mentioned in the instructions throughout this manual.



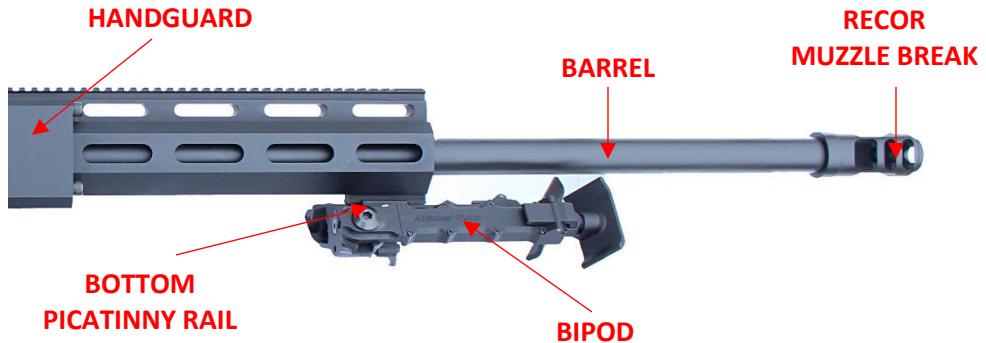

Upon unpacking, ensure all components are present, and inspect for obvious damage. Report any discrepancies or problems to HM Defense Customer Service at 937-444-6500 or info@hmdefense.com.

NOTE: Some illustrations in this manual may depict cosmetic difference not related to safety or performance.

THE SAFETY MECHANISM

The safety selector provides protection against accidental or unintentional discharge when fully engaged in the “**SAFE**” position. Use of the safety selector is not a substitute for following the rules of safe firearm handling.

The safety selector is located on the shooter’s left, towards the rear of the lower receiver. To engage the safety mechanism, rotate the safety selector counterclockwise, until the arrow of the safety selector points to the “**SAFE**” indicator. **SEE FIGURE 2, PAGE 15.**

Always place the safety mechanism in the “**SAFE**” position before handling, loading, or unloading the firearm.

When you are ready to discharge (**FIRE**) the firearm, rotate the safety selector to the “**FIRE**” position to disengage the safety mechanism. **SEE FIGURE 3, PAGE 15.**

WARNING! Never place your finger on the trigger unless you are ready to discharge (**FIRE**) the firearm even when the safety is engaged. An unintentional or uncontrolled discharge of your firearm may cause property damage, personal injury and/or death.

WARNING! Do not alter, bypass, or render the safety features of the firearm inoperative. Altering, bypassing, or rendering these features inoperative may cause property damage, personal injury and/or death.



ASSEMBLING THE HM50B

The rifle is shipped partially disassembled in the case. The following instructions outline how to properly assemble the HM50B.

1. Remove the complete upper receiver from the case and lay it on a stable, non-marring, surface with the picatinny rail down and upper lugs pointed up. At this point lubricate the upper lugs inside and out.
2. Remove the complete lower receiver from the case, with the hammer cocked, and the safety selector on **“SAFE.”** Next, fully open the rear takedown and front pivot pins. Position the lower receiver’s forward lugs over the upper receiver’s forward lug. (Some up, down and pushing motion will be required to align the lug holes) When the lug’s holes are aligned, push in the front pivot pin fully. Next, close the lower receiver onto the upper receiver and align the rear lugs. Push in the rear takedown pin fully. Never force the lower receiver pins into the upper receiver lugs. Use only light force. Forcing the pins may result in damage to the pins and/or lugs.

(Note: This is how we install the two primary receiver parts. There are other ways that you may find more comfortable to accomplish this process.) **SEE FIGURE 4 – PAGE 17.**

NOTE: Detents on both the pivot and takedown pins hold the pins in their retracted position and help reduce the potential for these pins to be lost.

Visit www.hmdefense.com to view our instructional videos for further assistance.



5. Remove the bipod from the case and attach to the picatinny on the bottom of the handguard. Secure tightly with a ½" wrench or socket.

LOADING THE HM50B

LOADING THE MAGAZINE

WARNING! Always check the ammunition for the correct cartridge marking (matching the markings on the barrel) before loading the firearm. Use of incorrect ammunition can result in property damage, personal injury, and/or death.

WARNING! The use of improperly loaded or hand-loaded ammunition can lead to barrel obstructions, excessive pressure and/or inadvertent discharge of a firearm, resulting in personal injury, property damage and/or death.

1. While holding the magazine on a flat surface as shown in **FIGURE 5**, position a cartridge of the proper type on top of the magazine between the feed lips and with the cartridge head flush with the rear, inside face of the magazine.

FIGURE 5

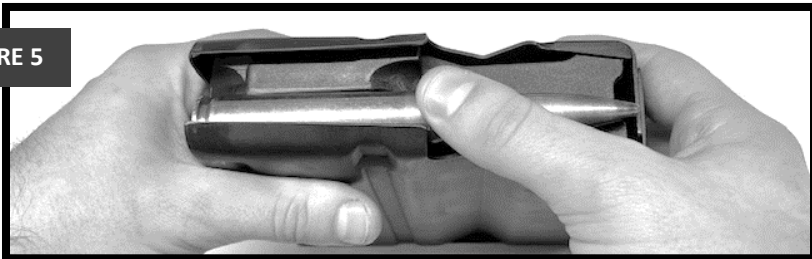

2. With the cartridge properly positioned, push down on the cartridge until it is fully seated in the magazine. Make sure the cartridge head is touching the rear inside face of the magazine.
SEE FIGURE 6
3. Place the next cartridge on top of the previously seated cartridge and push it down between the feed lips until it becomes seated in the magazine. The cartridges will sit staggered in the magazine with respect to the cartridge below it. The head of each cartridge should be touching the rear inside face of the magazine.
4. Repeat Step 3 until the magazine is full or the desired number of rounds have been loaded. Do not attempt to exceed magazine capacity as it may damage the magazine and your firearm.



FIGURE 6

LOADING THE FIREARM

WARNING! Never assume your firearm is unloaded. Always control the direction of the muzzle of your firearm, even if you think it is completely unloaded. Careless handling of any firearm can lead to property damage, personal injury and/or death.

WARNING! The firearm can be discharged with the magazine removed. If a cartridge is chambered, the bolt is closed and the Safety Selector is in the **“FIRE”** position, depressing the trigger will cause the firearm to discharge. An unintentional or uncontrolled discharge of your firearm may cause property damage, personal injury and/or death.

NOTE: A magazine may be inserted into this firearm’s lower receiver and a round chambered with the bolt assembly in either the open or closed position. However, the magazine will seat and lock into the lower receiver easiest, with the bolt in the open position.

WARNING! An unfired cartridge can discharge if left in a hot barrel. This is often referred to as a “cook-off”. If an unfired cartridge cannot be removed from a hot barrel quickly, remove the magazine from the firearm and allow the barrel and unfired cartridge to cool 15 minutes while maintaining control of the firearm and keeping the muzzle pointed in a safe direction. An unintentional or uncontrolled discharge of a firearm may cause property damage, personal injury and/or death.

1. Always keep the firearm pointed in a safe direction.
2. Place the safety selector in the **“SAFE”** position and remove the magazine. See “Unloading the HM50B” on pages 22 and 23 in this manual.

3. Open the bolt by lifting the bolt handle up and pulling fully rearward.
4. Verify the chamber is completely unloaded. See “Unloading the HM50B” on page 22 in this manual.
5. With the magazine facing forward (bullets of the rounds in the magazine will point towards the muzzle. Center the loaded magazine in the firearm’s magazine well. Insert the magazine until the magazine catch engages and holds the magazine.
6. Slap upwards on magazine bottom to ensure it is fully seated.
7. Pull down on the magazine bottom to verify it is securely engaged in the magazine well. If the magazine releases from the magazine well, repeat steps 5 through 7.
8. With a loaded magazine secured in the magazine well, push the bolt handle fully forward and down, closing the bolt and loaded cartridge into the chamber. Make sure the bolt handle is all the way down prior to firing.

WARNING! If the bolt does not close completely (the bolt handle does not travel all the way down in the slot in the upper receiver), the bolt handle must not be forced in any way. Open the bolt, eject the round, and inspect the chamber for cleanliness and any obstructions. See “Cleaning, Lubrication, and Maintenance” starting on page 27 of this manual. Hard bolt closure may indicate a number of conditions which, if forced, may result in excessive pressure being produced. Excessive pressure may result in property damage, personal injury and/or death to the shooter and/or bystanders.

9. Verify the safety selector is still in the “SAFE” position. If it is in the “FIRE” position, rotate it fully to the “SAFE” position.

WARNING! The firearm is now fully loaded with the safety selector in the “SAFE” position. Rotating the safety selector to the “FIRE” position and pulling/depressing the trigger will discharge the firearm. An unintentional discharge of a firearm may cause property damage, personal injury, and/or death.

UNLOADING THE HM50B

WARNING! Never assume your firearm is unloaded. Always control the direction of the muzzle of your firearm, even if you think it is completely unloaded. Careless handling of a firearm may cause property damage, personal injury and/or death.

1. Always keep the firearm pointed in a safe direction.
2. Engage the safety mechanism by placing the safety selector in the “SAFE” position. If the safety selector will not engage in the “SAFE” position, proceed to Step 3 with caution.
3. Press the magazine release button and remove the magazine box.
4. Pull the bolt handle up and then fully rearward.
5. Verify the safety selector is fully in the “SAFE” position. If the safety selector could not be engaged in Step 2, place it in the “SAFE” position now.

WARNING! IF the safety selector still cannot be engaged fully in the “SAFE” position the firearm is NOT in a safe operating condition and must NOT be used until it is inspected, and the problem corrected by a qualified gunsmith. The use of a firearm that is not in a safe operating condition may result in property damage, serious personal injury, and death. See “Repair Instructions” on page 41.

6. Look into the ejection port and visually check the chamber and magazine well for cartridges to make sure the firearm is completely unloaded.

THE BARREL

CHECKING FOR OBSTRUCTIONS

WARNING! The inside of the barrel must be clean and free of obstructions. Discharging a firearm with an obstructed barrel may cause property damage, personal injury and/or death.

1. Always keep the firearm pointed in a safe direction.
2. Completely unload the firearm, both chamber and magazine by following the steps detailed in “Unloading the HM50B” on page 22 of this manual.
3. Remove the upper receiver and the bolt carrier group.
4. Next, push a cleaning rod with a properly sized patch or bore brush completely through the barrel starting at the chamber end until the rod can be seen protruding from the muzzle end.

REMOVING OBSTRUCTIONS

WARNING! NEVER try to remove an object from the barrel by loading another cartridge and firing. This may cause the barrel to burst or cartridge to rupture causing property damage, personal injury and/or death.

If you have a case stuck after firing case, **DO NOT BEAT** on the bolt handle. To avoid damage to the crown, use a 5/16 wooden dowel rod from the muzzle end, **with the bolt handle in the up position**, tap on the dowel rod to free the stuck case.

1. Always keep the firearm pointed in a safe direction.
2. Completely unload the firearm, both chamber and magazine by following the steps detailed in “Unloading the HM50B” on page 22 of this manual.
3. Insert a cleaning rod through the chamber end of the barrel until it is protruding from the muzzle end.
4. Lightly tap the cleaning rod to remove the obstruction towards the muzzle until the end of the cleaning rod can be seen and the obstructing material or object can be removed.
5. Repeat the steps detailed under “Checking for Obstructions” on the previous page to ensure the barrel is free of obstructions. Repeat Steps 1 through 4 as needed.
6. If an object cannot be easily pushed out of the barrel with a cleaning rod, contact HM Defense or your qualified local gunsmith.

FIRING THE HM50B

WARNING! Always wear eye and hearing protection when discharging any firearm. Failure to do so may result in personal injury. See the 10 RULES OF FIREARMS SAFETY section in this manual.

WARNING! The inside of the barrel must be clean and free of any obstructions. Discharging a firearm with a dirty and/or obstructed barrel may cause property damage, personal injury, and/or death. See the 10 RULES OF FIREARM SAFETY section of this manual.

WARNING! Never discharge a firearm with water or other obstruction in the barrel. Discharging a firearm with water, excess oil or grease or other obstructions in the barrel may cause property damage, personal injury and/or death.

NOTE: Your HM Defense HM50B rifle will require shooting about 50 rounds to break-in properly.

1. Always keep the firearm pointed in a safe direction.
2. Load the firearm. See “Loading the Firearm” on page 20 of this manual.
3. Mount the butt stock of the firearm firmly against your shoulder prior to firing.
4. Point the muzzle at your intended target and acquire the target using a scope or sighting system. Always know what is beyond your target.
5. Rotate the safety selector to the “**FIRE**” position.
6. Pull the trigger. The firearm will discharge.

WARNING! If a cartridge does not discharge when the trigger is pulled (misfire), maintain control of the firearm and keep it pointed in a safe direction and wait two minutes before opening the bolt or the action. See the “Unloading Your Firearm” section of this manual. Failure to wait the allotted time may result in property damage, personal injury, and/or death from a delayed and/or uncontrolled discharge of the cartridge.

WARNING! If the “report” of a discharged cartridge is noticeably softer or louder or in any way irregular, stop shooting. While keeping the muzzle pointed in a safe direction, completely unload the firearm, and check for bore obstructions. See “The Barrel” starting on page 23 of this manual. Discharging a firearm with an obstructed barrel may cause property damage, personal injury, and/or death.

WARNING! If the recoil of the firearm when you fire a round is harder or softer, or any way irregular, stop shooting. While keeping the muzzle pointed in a safe direction, completely unload the firearm, and check for bore obstructions. See “The Barrel” starting on page 23 of this manual. Discharging a firearm with an obstructed barrel may cause property damage, personal injury, and/or death.

7. After you have fired the round, pull the bolt handle up and then fully rearward. The fired cartridge case will be extracted from the chamber and ejected during this action.
8. When you are done shooting, without touching the trigger, fully rotate the safety selector lever to the “SAFE” position.
9. Press the magazine release button and remove the magazine box.
10. Look into the ejection port and visually check the chamber for cartridges to make sure the firearm is completely unloaded.

CLEANING, LUBRICATION, AND MAINTENANCE

WARNING! Never perform maintenance or repairs on a firearm that has not been verified to be completely unloaded including the chamber and magazine. Always ensure the safety mechanism is engaged to the “**SAFE**” position before proceeding. Failure to verify the firearm is completely unloaded prior to performing maintenance may result in property damage, personal injury, and/or death. See “Unloading the Firearm” on page 22 of this manual.

WARNING! The trigger of the HM50B is a target trigger designed and made by HM Defense. It is **NOT** adjustable. Never manipulate, modify, adjust, or change any of the internal components of your firearm. Improper manipulation of any internal component may affect the safety and reliability of your firearm and may result in property damage, personal injury, and/or death.

1. **BEFORE FIRING THE RIFLE:** Verify the bore and chamber are clean and clear of debris. **The chamber should be dry and free from oil and grease.** Thoroughly clean and dry the bore and chamber. Use coated or nonmarring cleaning rods by inserting them from the chamber to the end of the barrel. Be careful not to damage the muzzle crown (the junction of the rifling and the flat end of the muzzle) since this affects the accuracy of the rifle.
2. **AFTER FIRING THE RIFLE:** The rifle should be cleaned and lubricated as soon as possible after each shooting session. After every 50 rounds it is recommended that the bore be scrubbed with a copper solvent to remove deposits. Clean the chamber with a nonaggressive cleaner and wipe clean. It is important **NOT** to scratch or mar the chamber.

3. **STORAGE** When the firearm is to be stored, it should be carefully cleaned and thoroughly oiled as described below. **For longer term storage, the bore, chamber, bolt carrier group and outside metal surfaces should be wiped with quality gun oil before being stored and again at least every six months.**

DISASSEMBLING FOR CLEANING (FIELD STRIPPING)

1. Always keep the muzzle pointing in a safe direction. Ensure firearm is not loaded.
2. Place the safety selector in the “**SAFE**” position.
3. Push out the rear takedown pin until its fully opened, pivot the upper receiver to the open position, push the front pivot pin out, and separate the upper and lower receivers.
4. Place the upper receiver on a flat, secure, non-marring work surface.

REMOVING THE BOLT CARRIER GROUP

5. Check To ensure the firearm is completely unloaded, both chamber and magazine. See “Unloading the Firearm” on page 22 of this manual.
6. With the bolt closed and the bolt handle rotated fully downward, use the 3/32” hex key (provided) to loosen the bolt handle set screw about 1/8” (4-5 turns). **SEE FIGURE 7 – PAGE 29. DO NOT FULLY REMOVE THE SET SCREW.**
7. Unlock the bolt by rotating the bolt handle to its up position.
8. Remove the bolt handle and bolt handle bushing by lifting them from the bolt. **SEE FIGURE 8 – PAGE 29.**
9. **Carefully slide the bolt carrier group to the rear opening of the upper receiver and remove it from the upper receiver.**

FIGURE 7

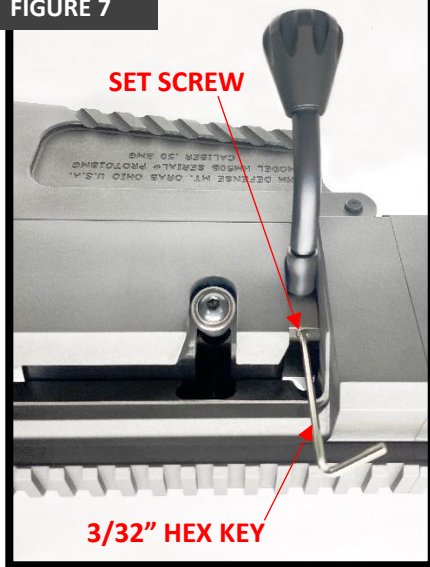
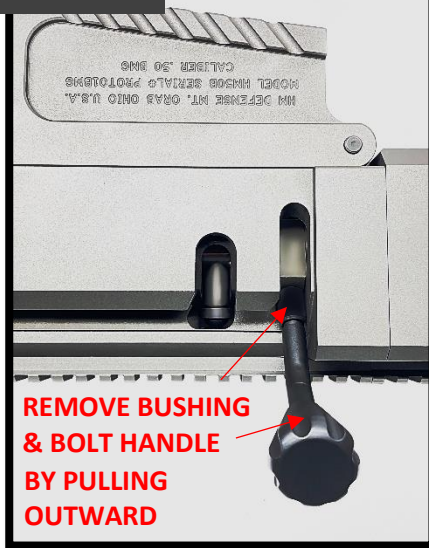
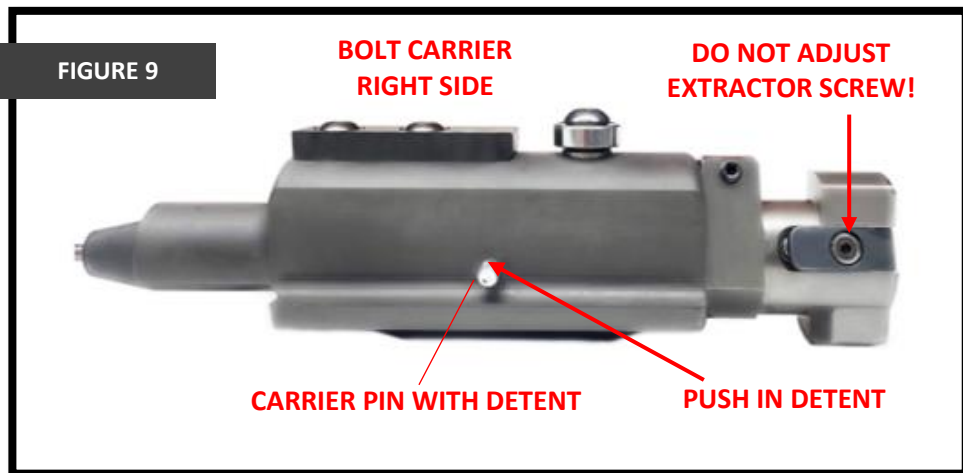

FIGURE 8



DISASSEMBLING THE BOLT CARRIER

1. Remove the carrier pin by driving out the carrier pin using a small flat punch.
SEE FIGURE 9
2. Loosen (**do not remove**) the firing pin extension set screw on the left side of the bolt carrier using a 1/8" hex key and remove the firing pin extension. **SEE FIGURE 10**
3. **DO NOT ADJUST EXTRACTOR SCREW.** **SEE FIGURE 9**



- Carefully remove the firing pin from the carrier.
- Next remove the cam pin from the bolt as **shown in FIGURE 10**.
- Remove the bolt from the carrier.
- Remove the firing pin spring from the bolt. (If the firing pin spring does not freely fall from the bolt, use a small punch to push the firing pin spring out.)

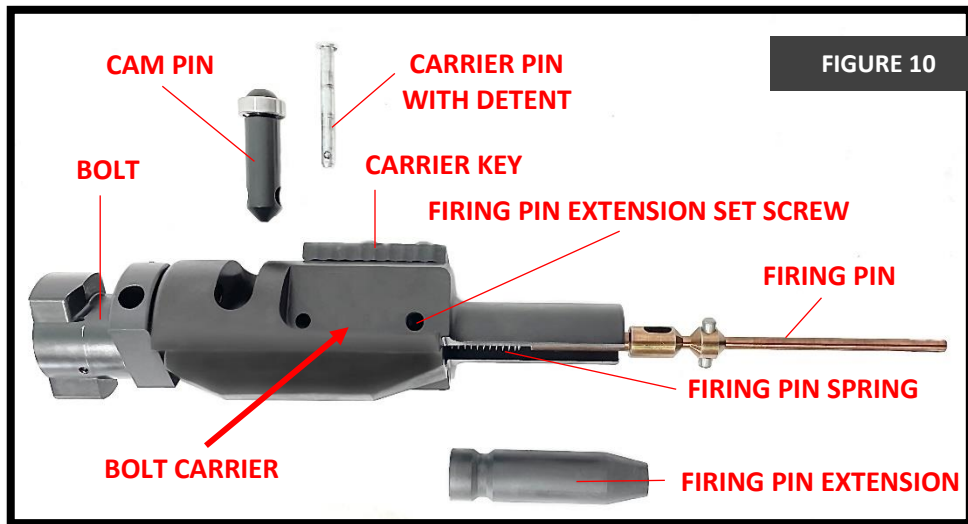

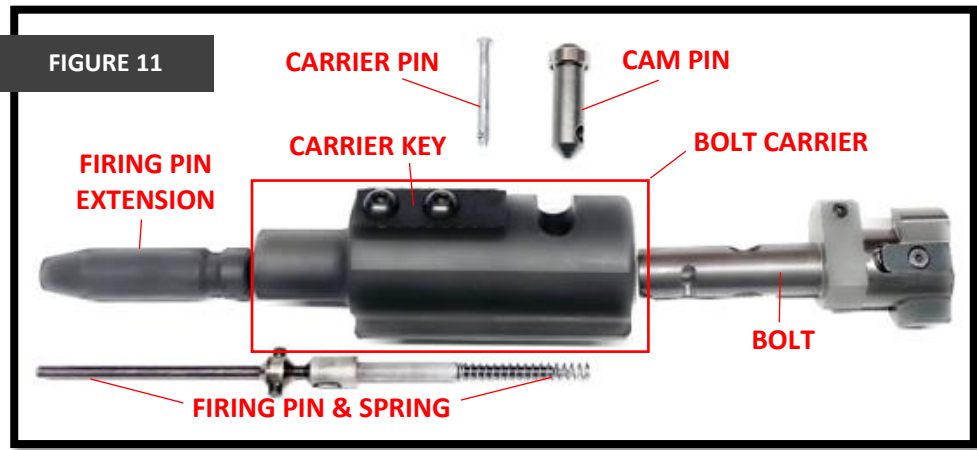

Figure 11: Disassembled Bolt Carrier. Shown above are the disassembled components of the Bolt Carrier Group.



STOP! HM DEFENSE DOES NOT RECOMMEND DISASSEMBLING BEYOND THIS POINT. DOING SO WILL VOID YOUR WARRANTY.

CLEANING AND LUBRICATING

WARNING! Unload the firearm before cleaning. Look into the ejection port and visually check the chamber and magazine to make sure there are no cartridges in the firearm. Always wear eye protection when handling, disassembling, and reassembling the firearm. Failure to follow these instructions may cause property damage, personal injury and/or death.

THE BARREL

1. Remove the bolt carrier group. See instructions starting on page 28.
2. Select the correct caliber cleaning brush for your firearm and attach the brush to the cleaning rod.
3. Place the cleaning brush into a quality cleaning solvent for bore cleaning.
4. Push the cleaning brush through the barrel several times, from the chamber to muzzle.
5. Remove the cleaning brush from the cleaning rod. Attach a tip with a patch and push the patch through the bore several times.
6. Repeat steps 3 through 5 as needed, using a new patch each time, until the patch comes out clean.
7. Push a clean patch soaked with gun oil through the barrel if you plan on storing the firearm.
8. Push a clean patch through the bore to remove excess lubrication prior to firing.
9. Verify all patches have been removed from the barrel after cleaning.

WARNING! After cleaning, make sure the barrel is free of obstructions, see “The Barrel” on page 23 of this manual. Discharging the firearm with a dirty and/or obstructed barrel may cause property damage, personal injury and/or death.

UPPER RECEIVER & LOWER RECEIVER: Periodic cleaning of the ID of the upper receiver (inside of the upper receiver) is required to ensure proper function of the bolt carrier group. After cleaning the upper receiver, oil the contact points where the bolt carrier rides. Clean and lubricate the bolt carrier group, verify the firing pin is moving freely in the bolt.

CLEANING THE LOWER RECEIVER AND ITS LUBRICATION: Clean or blow out dust and any debris from the lower receiver trigger mechanism and safety. **Never lubricate the trigger and hammer engagement area**, lubricate the safety, pivot pin, and take down pin. Lubricate the magazine catch assembly and test its function. It should move freely.

BOLT CARRIER GROUP: The parts of the bolt carrier group should be cleaned and then lightly oiled before reassembly. **SEE FIGURE 11, PAGE 32** for bolt and bolt carrier disassembly and reassembly. Apply a light coating of quality gun grease to the bolt carrier key and bolt lug faces.

BIPOD ASSEMBLY: Clean the bipod assembly to remove any dirt or debris. Lubricate all moving parts as needed.

REASSEMBLING THE HM50B

WARNING! The firearm owner and user must accept full responsibility for the correct reassembly and functioning of the firearm after disassembly or replacement of parts. Incorrectly assembling the firearm or the use of modified or incorrect parts may result in property damage, personal injury and/or death.

1. Insert the bolt into the bolt carrier after lightly greasing the back lug surface of the bolt. With the cam pin recess in the up position, insert the cam pin with the cam's firing pin hole aligned with the bore of the carrier. **SEE FIGURE 12, PAGE 36**
2. Insert the firing pin and firing pin spring at the same time, fully into the bolt. Ensure the firing pin's limit pin is seated in the bolt recesses. **SEE FIGURE 13, PAGE 36**
3. Insert the carrier pin for the firing pin from the left side of the bolt carrier. You may need to slightly rotate the bolt to allow alignment and insertion of the carrier pin, or you may need to adjust the position of the firing pin. Once fully inserted, the carrier pin will protrude on the right side of the bolt carrier and will be held in place by its spring and detent mechanism. **SEE FIGURE 9, PAGE 30 for carrier pin location).**
4. Install the firing pin extension (large end first) over the rear portion of the firing pin. **SEE FIGURE 10, PAGE 31** Secure the extension in place by tightening the set screw located in the left side of the bolt carrier using a 1/8" hex key provided. Tighten until the set screw bottoms out in the set screw recess.
5. Align the carrier key and the cam pin to the 12 o'clock position with the upper receiver channel. **SEE FIGURE 14, PAGE 37.** Slide the bolt and carrier group forward until it contacts the barrel extension.
6. Insert the bolt handle and bolt handle bushing into the bolt handle recess and tighten the bolt handle set screw into its recess, located on the top of the bolt handle shaft, with the 3/32 hex key. We recommend using non-permanent Loctite on the threads of the set screw. Secure tightly. **SEE FIGURE 15, PAGE 37**
7. Assemble the upper receiver to the lower receiver as detailed in "Assembling the HM50B" on pages 16 and 17".

FIGURE 12

**LIGHTLY GREASE
BACK OF LUGS**



**ALIGN FIRING
PIN HOLE
WITH BORE
OF CARRIER**

BOLT RECESSES

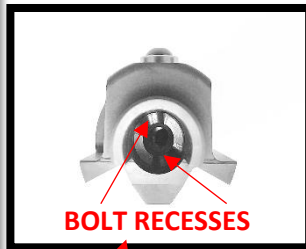

LIGHTLY GREASE CARRIER KEY SLIDES

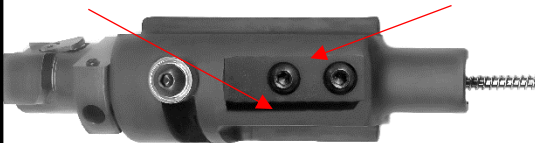

LIMIT PIN

FIGURE 13

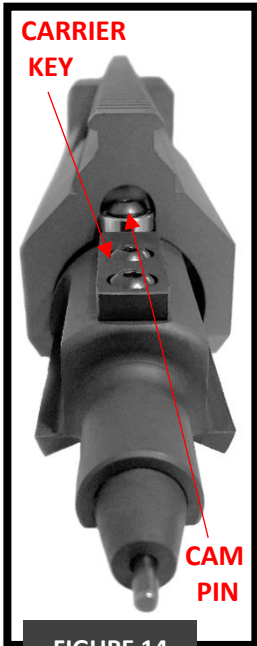

FIGURE 14

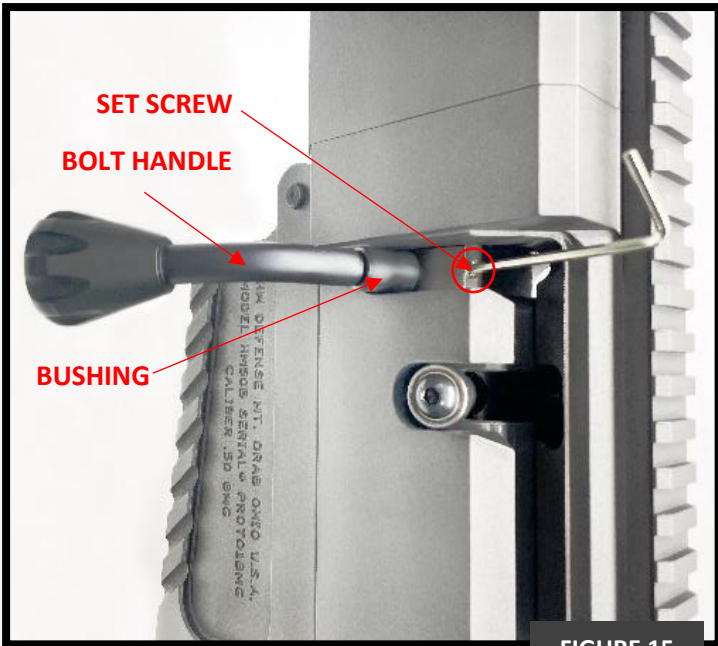

FIGURE 15

FUNCTION TESTING THE HM50B

During reassembly and after reassembly is complete, a function test should be conducted to ensure proper operation of the firearm, before loading or discharging the firearm. If the firearm does not function as described in any part of the function test procedure, the firearm is **NOT** in a safe condition. The firearm must **NOT** be used until you have it inspected and any issues corrected by a qualified gunsmith or HM Defense.

WARNING! If the firearm experiences a malfunction during the function test, the firearm is **NOT** in a safe operating condition and it must **NOT** be used until you have it inspected and the problem corrected. The use of a firearm that is not in a safe operating condition may result in property damage, personal injury, and/or death.

WARNING! Completely unload the firearm (both chamber and magazine) before function testing. See “Clearing/Unloading the Firearm and Magazine” section in this manual. Always wear eye protection when handling, disassembling, and reassembling the firearm. Failure to follow these instructions may cause property damage personal injury, and/or death.

1. Always keep the firearm pointed in a safe direction.
2. Place the safety selector in the “**SAFE**” position and remove the magazine. See “Unloading the HM50B” on pages 22 and 23 of this manual.
3. Open the bolt by pulling the bolt handle up and fully to the rear.
4. Visually and physically verify the chamber is completely unloaded. See “Unloading the HM50B” on pages 22 & 23 of this manual.

- Remove the bolt carrier group from the upper receiver. Apply pressure to the rear of the firing pin when the bolt is in the firing position. The firing pin should depress freely against the firing pin spring. If the firing pin does not depress, see **Figure 10**, **page 31** to ensure the firing pin was installed properly.
- Examine the bolt face to ensure the firing pin **IS protruding** from the bolt face when in the firing position. See **Figure 16**.
- Examine the bolt face to ensure the firing pin **IS NOT** protruding when the bolt is in the open or non-firing position. See **Figure 17**.

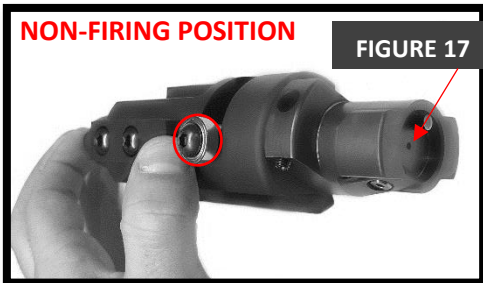
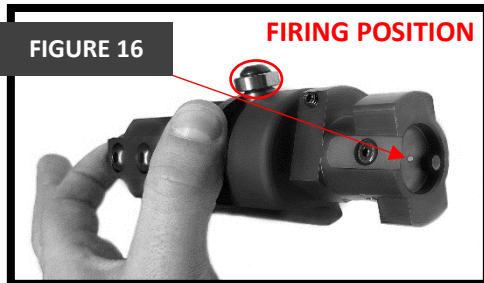

WARNING! Failure of the firing pin to retract when the bolt handle is lifted indicates the rifle is **NOT** in a safe operating condition and must **NOT** be used until you examine, inspect and determine the cause of the failure.

- Insert the bolt carrier group into the upper receiver bolt end first and with cam pin and carrier key aligned at the 12 o'clock position.

9. Close the bolt by pushing the bolt handle fully forward and down.
10. Assemble the upper receiver to the lower receiver as detailed in “Assembling the HM50B” on page 16 and 17 of this manual.
11. After closing the upper receiver on the lower receiver, work the bolt carrier, by moving the bolt handle back and forth and moving the bolt handle into its down position. The capture bearing, located in the bolt carrier, will create a camming affect when the bolt handle is moved into the down or captured position. The camming effect on the bolt handle gives the operator an indication the bolt is closed when the bolt handle is in its fully down position. This is in addition to visually inspecting the bolt handle is in the fully down position prior to firing the firearm.
12. If the bolt handle does not seat into the captured or fully down position, contact HM Defense for trouble shooting instructions.
13. After confirming the firing pin and bolt carrier group are functioning and the bolt handle has been captured into the down position, the firearm is ready to operate.
14. With the safety selector in the “**FIRE**” position. With the firearm still pointed in a safe direction, pull the trigger. The hammer should release. Repeat this multiple times.
15. Remove your finger from the trigger and verify the trigger returns to the fully forward position.
16. Place the safety selector in the “**SAFE**” position and remove the magazine. See “Unloading the HM50B” on pages 22 and 23 of this manual.

REPAIR INSTRUCTIONS

HOW TO OBTAIN SERVICE FROM HM DEFENSE:

PLEASE HAVE THE FOLLOWING INFORMATION READY BEFORE YOU CALL OR INCLUDE IT IN YOUR EMAIL. Please call 937-444-6500 or email info@hmdefense.com

1. Firearm model and serial number.
2. Date and location of purchase. Are you the original owner?
3. Type of service requested and detailed description of condition.
4. Your complete mailing address (P.O. Box and Street Address) including zip code, telephone number and e-mail address.
5. Method of payment: Credit card number and expiration date. A quote may be made to you over the phone.

WARNING! Use only HM Defense parts in HM Defense firearms. The use of unapproved components or incorrect parts in HM Defense's firearms will void the warranty and can result in property damage, personal injury, and/or death.

WARNING! Do not send live cartridges with your firearm.

REPAIR SERVICE

If there is a defect with your HM Defense firearm that (A) you believe is, or should be, covered by the Warranty, (B) you would like HM Defense to address at your cost and expense, or (C) you would otherwise like to discuss with HM Defense; please contact HM Defense Consumer Service at 937-444-6500 or info@hmdefense.com. Please do not send your firearm or other item to HM Defense without first (A) calling 937-444-6500, (B) receiving instructions from an HM Defense representative, and (C) obtaining a Service Request Document. HM Defense will either e-mail this document to you or if you do not have an e-mail address, HM Defense will mail a copy to you. Please be sure to store your Service Request Document in your records so it will be both safe and accessible. Finally, to the extent you seek Warranty coverage, please review the Warranty for you HM Defense firearm and note that you may void your Warranty by acting without first contacting HM Defense.

To register your Warranty, please complete the Warranty Registration Card that accompanied your HM Defense firearm within 90 days of purchase. If shipment of your firearm is required, a Service Request Document must be obtained prior to shipment and please follow the instructions below:

1. Record the serial number of your firearm before shipping.
2. Ensure your firearm is unloaded. To unload your firearm, see the “Unloading the HM50B” section on pages 22 and 23 this manual.
3. Pack your firearm securely in the original hard case provided with your firearm. We recommend an outer shipping box to cover your original hard case.
4. Remove all accessories from the firearm to prevent loss or damage. Do not ship with optics and mounts.

5. Include your Service Report Document, full name, address including zip code, daytime telephone number and email address.
6. Check your state and local regulations, along with Federal laws, before shipping.
7. When you ship your firearm, HM Defense is not responsible for damage or loss during shipment. We recommend photographing your parts in your original case prior to shipment. This can aid in processing any potential insurance claims you may encounter due to shipping losses or damage.

WARRANTY

Please complete your warranty registration card enclosed in your rifle case and return to HM Defense within 90 days of your purchase to receive the full benefit of your Limited Firearm Warranty.

HM Defense & Technology conditionally warrants your firearm for a period of five years from the date of purchase. Review your warranty and disclaimer information on our website for full warranty details. www.hmdefense.com

Upon receiving notice from the initial purchaser, HM Defense shall have the option of repairing or replacing any part claimed or found to be defective. This warranty does not cover any condition determined by HM Defense to be caused by or arising out of unauthorized repairs or modifications, negligent or careless use, normal wear and tear, abuse, failure to properly store or maintain the product, disassembly beyond the FIELD STRIPPING instructions in this manual, use of defective or improper ammunition, corrosion, or neglect. This warranty is exclusive and is in lieu of all or any other warranties written or oral, expressed, or implied.

WARNING: Suppressor installation must be performed by a professional gunsmith. Installing a suppressor requires specific knowledge, fixtures and tools. Failure to follow this instruction will void your HM50B warranty. Unprofessional suppressor installation can result in damage to the firearm and create unsafe headspace causing serious injury and/or death.

DO NOT REMOVE THE BARREL NUT, DOING SO CAN RESULT IN CHANGING THE HEADSPACE AND CREATE AN UNSAFE OPERATING CONDITION WHICH MAY RESULT IN PROPERTY DAMAGE, PERSONAL INJURY AND/OR DEATH.

HM DEFENSE MAKES NO WARRANTY OF MERCHANTABILITY OR FITNESS FOR PARTICULAR PURPOSE. HM DEFENSE SHALL HAVE NO LIABILITY FOR INCIDENTAL OR CONSEQUENTIAL DAMAGES.

DISCLAIMER OF LIABILITY: HM Defense disclaims any liability for personal injury, property damage or economic loss caused in whole or in part by handloaded, reloaded, SLAP, surplus, remanufactured or defective ammunition. Under no circumstances will HM Defense be liable for personal injury, property damage or economic loss resulting from unsafe handling of the firearm, illegal use of the firearm or unauthorized modifications to the firearm.

DO NOT ALTER OR MODIFY YOUR FIREARM – IT WILL VOID YOUR WARRANTY

Your firearm has been designed to operate according to certain factory specifications. You will jeopardize your safety and that of others around you by attempting to alter its trigger, mechanical safety and/or other mechanism. Never alter or modify your firearm in any way. Modifications or alterations will void your warranty.

THE HM50B IS A RUGGED RIFLE BUILT TO WITHSTAND EXTREME CONDITIONS

Complimenting your HM50B are accessories selected specifically for their quality and durability. Below is the list of accessories chosen by HM Defense, as well as links to the companies that manufacture each accessory.

ACCU-TAC HD-50 Bipod with sled feet <https://accu-tac.com>

ERGO Tactical Deluxe Grip – Suregrip (Ambi) <https://www.ergogrips.net>

Magpul PRS Gen 3 Precision - Adjustable Stock <https://magpul.com>

ACCU-TAC[®]
PRECISION BIPODS AND ACCESSORIES



THIS OWNER'S MANUAL SHOULD ALWAYS ACCOMPANY YOUR HM DEFENSE
FIREARM AND BE TRANSFERRED WITH IT UPON CHANGE OF OWNERSHIP.

HM50B



HM DEFENSE & TECHNOLOGY
222 HOMAN WAY
MT. ORAB, OH 45154

INFO@HMDEFENSE.COM 937-444-6500 WWW.HMDEFENSE.COM